

Repetitive Controller Based Grid Current Compensator for Distributed Generation

Priyanga D¹ and Jisi N.K²

¹PG Scholar, ²Assistant Professor,

^{1,2}Department of Electrical & Electronics Engineering,

^{1,2}Thejus Engineering College, Thrissur, India

Priyadraj31@gmail.com¹, jisink@gmail.com²

Abstract: *The expansion of electric grid has made the conventional power system to be more prone to power quality issues especially harmonics. The injection of harmonics will lead to generation of poor quality grid current. Conventionally filters are used to avoid such problems, but they are bulky. This paper proposes an improved current controller to provide a high quality grid current under nonlinear loads and voltage distortions. The proposed control scheme uses a combination of proportional integral (PI) controller and repetitive controller (RC) and is employed in synchronously rotating reference frame. The repetitive control gives a simple and practical solution for multiple harmonics compensation. The proposed control does not require local load current measurement and grid voltage harmonic analysis. Thus it can be incorporated into the conventional system without the usage of any additional hardware. It provides better grid current quality compared to that of conventional PI controller. The control strategy is analyzed. Simulation results are presented to validate the feasibility of the proposed controller.*

Keywords - *Distributed Generation (DG), Distributed Generation (DG), Grid connected converters, Harmonic compensation, Nonlinear load, Voltage distortion, Repetitive controller*

I. Introduction

The increasing concern about the environmental aspects and available fossil fuel reserves and has given a more importance to the use of distributed generation (DG) [1]–[4]. Renewable energy sources such as wind, solar and micro turbines have been considered as potential sources to replace traditional fossil energy sources. Use of renewable energy sources have been integrated into power distribution systems in the form of distributed generation (DG), which has several advantages such as small size, clean electricity, low cost, high efficiency and peak shaving. DG units can be operated either in a grid-connected mode or in an islanded mode [4]. Mostly DG units are designed to operate in the grid-connected mode with various functions such as reactive power compensation, harmonic rejection and power control [4]-[7]. In grid-connected DG systems, three-phase pulse width-modulation (PWM) voltage-source inverters (VSIs) are often employed for power conversion, grid synchronization and control optimization [7], [8]. In addition, to fully utilize the advantages of a DG system, the DG can be also installed with local loads, wherein the DG supplies power to the local load and transfers extra power to the grid [8]–[10]. In both cases, i.e., with and without the local load, the main objective of the DG system is not only extract maximum available power from the renewable energy sources but also provide a high performance current into utility network with strict standards as in [18],[19]. The total harmonic distortion (THD) of the grid current is limited to 5%, as recommended in the IEEE 1547 standards [20]. In [9], the operation of space vector based hysteresis current control in synchronous reference frame for grid connected VSC is proposed, which allows systematic application of zero voltage vectors and prevents high switching frequency caused by phase interaction. This provides fast dynamic response but requires complex filter design. An advanced space vector pulse width modulation (SVPWM) based predictive current (PC) controller for three phase inverters is introduced in [10], which is simple and robust to implement with a digital

signal processor (DSP). But, its control performance relies on system parameters. In [11], multiple harmonics control for three phase grid converters is proposed, which uses a hybrid system consisting of a PI controller plus an n th harmonic resonant controller implemented in dq frame at the n th harmonic frequency. Thus proportional integral (PI) controllers in synchronously rotating (dq) reference frame have been regularly employed due to its simplicity and robustness [11]. In dq reference frame, ac current signals behave as dc quantities, which are easily regulated by the conventional PI controllers. The main drawbacks of conventional PI controllers include steady state errors in a single phase system and the need for dq frame transformations. Recently, a proportional-resonant (PR) controller in stationary reference frame has been introduced as an alternative solution to achieve the same desired performance as PI controllers in synchronously rotating reference frame. Proportional resonant (PR) controllers and filters for grid connected VSC are investigated in [12], which have unique feature of compensating for both positive and negative sequence components simultaneously, unlike synchronous PI where separate frame transformations are needed.

These conventional current control methods are effective only when grid voltage is ideally balanced and pure sinusoid. Practically, a pure sinusoidal grid voltage is rare. Due to the use of numerous nonlinear loads such as diode rectifiers and adjustable-speed AC motor drives in utility network and the core saturation of transformers in power system, the grid voltage measured at point of common coupling (PCC) contains harmful harmonic components. The abnormal grid voltage conditions can strongly deteriorate the performance of the grid current. But, the fifth and seventh harmonics severely affect to the current performance, and they will appear in current waveform, where the fifth harmonics is negative sequence and the seventh harmonics is positive sequence. Resonant controllers can be effectively used for multiple harmonics compensation. Adding more controllers would increase the system complexity. Thus, repetitive controllers can be implemented which acts as a bank of resonant controllers to compensate a large number of harmonic components with a simple delay function.

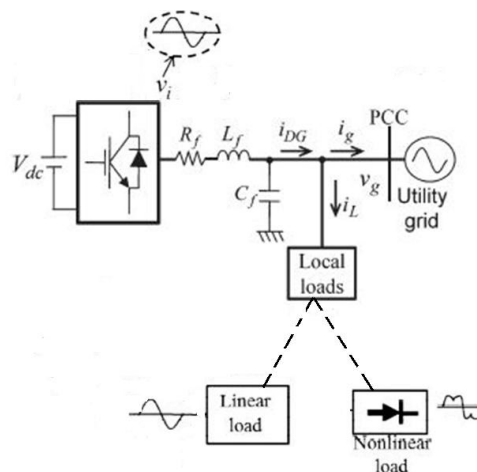

Fig. 1. Connection interface of DG with various loads

In [13],[14],[15] and [17] several compensation methods are introduced to reduce the harmonics and thereby improve grid current quality but these all may increase the complexity of the system. The repetitive control technique has been adopted in [5]. A repetitive controller (RC) serves as a bank of resonant controllers to compensate a large number of harmonic components. However, despite the effectiveness of the RC in harmonic compensation, RC has a long delay time, which limits the dynamic response of the current controller. Along with grid voltage distortion, the presence of nonlinear loads in the local load of the DG also causes a negative impact on the grid current quality

[15]. To address this problem, the local load current measurement and a load current feed forward loop are regularly adopted [14]. Although these compensation methods are effective in improving grid current quality, the requirement of additional hardware, specifically the current sensor for measuring the local load current, is the main drawback of this control method. Furthermore, most aforementioned studies consider and separately tackle the impact of distorted grid voltage or the nonlinear local load; none of them simultaneously takes into account those issues. In this paper, an improved control strategy is proposed to achieve a high quality current in grid connected converters under distorted grid condition. The paper proposes an advanced current control strategy using PI-RC controller for the grid-connected DG, which provides a sinusoidal grid current by simultaneously eliminating the effect of nonlinear local loads and grid voltage distortions. Firstly, the influence of the grid voltage distortions and nonlinear local load on the grid current is determined. Then, an advanced control strategy is introduced to address the issues caused by them. The proposed current controller is designed in the dq reference frame. With the use of proposed control scheme, the grid current quality will be improved compared with that of the traditional PI current controller. In addition, with the combination of the PI and RC, the dynamic response of the proposed current controller is also greatly enhanced compared with that of the traditional RC. The feasibility of the proposed control strategy is completely analyzed and verified by simulation results.

II. System Configuration and Analysis

The configuration of a three phase DG operating in the grid connected mode is shown in Fig. 2. It mainly includes a dc power source, a voltage source inverter (VSI), an output LC filter, local loads, and the utility grid.

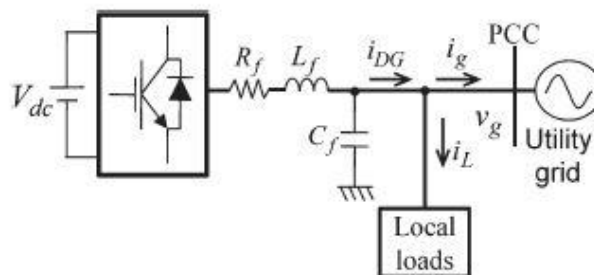

Fig. 2. DG in grid connected mode

DG system supplies power to its local load and transfer the surplus power to the utility grid connected to the PCC. The current transferred by the DG to the grid (i_g) should be sinusoidal, balanced and have a low THD value, so as to provide a high quality power to the utility grid. Due to the typical existence of grid voltage distortion and nonlinear loads in the power system, it is not easy to satisfy these requirements. A detailed analysis on the effects of grid voltage distortion and nonlinear loads are explained in detail in [9]. Two cases that affect the grid current quality are:

- A Effect of nonlinear load.
- B Effect of grid voltage distortion.
- A. *Effect of nonlinear load*

A model of the grid connected DG system is developed to determine the impact of grid voltage distortion on the grid current of the DG. In this model, the VSI of the DG is simplified as voltage source (V_i). The inverter transfers a grid current (i_g) to the utility grid with V_g . For simplification, it is assumed that the local load is not connected into the system. If both the grid voltage and the inverter voltage are composed of the fundamental and harmonic components due to the presence of the harmonic components V_{gh} in the grid voltage, the harmonic currents i_{gh} are induced into the grid

current if the DG cannot generate harmonic voltages V_{ih} that are exactly the same as V_{gh} . As a result, the distorted grid voltage V_g causes non-sinusoidal grid current i_g if the current controller cannot regulate harmonic grid voltage V_{gh} .

B. Effect of grid voltage distortion

Here, we consider a grid-connected DG system with a local load, whereby the local load is represented as a current source i_L , and the DG is represented as a controlled current source i_{DG} . Assuming that the local load is nonlinear, e.g., a three-phase diode rectifier, the load current is composed of the fundamental and harmonic components. In order to transfer sinusoidal grid current i_g into the grid, DG current i_{DG} should include the harmonic components that can compensate the load current harmonics i_{Lh} . Therefore, it is important to design an effective and low cost current controller that can generate the specific harmonic components to compensate the load current harmonics. Generally, traditional current controllers, such as the PI or PR controllers, will not be effective because they lack the capability to regulate harmonic components.

III. Proposed Current Control Scheme

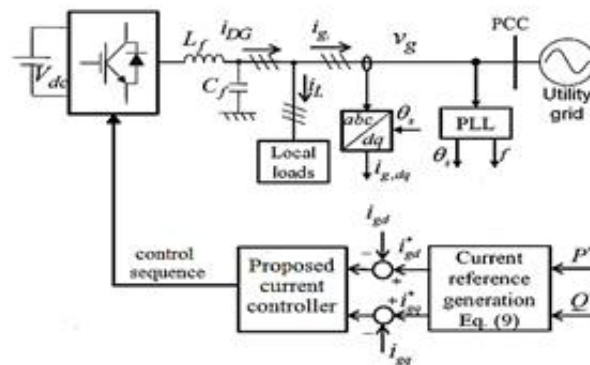

Fig. 3. Overall block diagram of the proposed control strategy

For improving grid current quality, an advanced current control strategy by using PI-RC controller, as shown in Fig.3, is introduced. The control method based on PI for current regulation is used. The proposed system is composed of PI and RC controllers and is developed in dq frame. This proposed control scheme has three main parts, the PLL (phase locked loop), the current reference generation scheme, and the proposed current controller. PLL is used to determine the frequency and phase angle reference of the PCC (point of common coupling) [16]. An important aspect to consider in grid connected operation is synchronization with grid voltage for upf (unity power factor) operation, wherein it is essential that grid current reference signal (i_g^*) is in-phase with the grid voltage (V_g) [8]. Here, the grid synchronization is carried out by PLL. The output current from filter which has been transformed into synchronous frame (dq frame) by Park's transformation and regulated in dc quantity, is fed back and compared with reference current. This generates a current error i.e., passed to the current controller to generate voltage reference for the inverters. In order to get dynamic response, V_{dq} is feed forward. This is done because, the terminal voltage of the inverter is treated as a disturbance and the feed forward is used to compensate for it. The voltage reference in dc quantities are transformed into stationary frame by inverse Park's transformation and are used as command voltages in generation of high frequency voltages [5]. As shown in Fig.3, the control strategy operates without any harmonic voltage analysis of grid voltage. Therefore, it can be developed without any extra hardware. Also it can simultaneously address and eliminate effects of the nonlinear local loads and distorted grid voltage conditions on the grid current quality [3].

Reference Current Calculation

The current references for the current controller in the dq reference frame are generated. The current references are determined using (1) as below,

$$\begin{aligned} i_{gd} &= \frac{2 P}{3 V_{gd}} \\ i_{gq} &= \frac{-2 Q}{3 V_{gd}} \end{aligned} \quad \dots (1)$$

where i_{gd} and i_{gq} are the direct and quadrature components of the grid current, respectively; P^* and Q^* represents the reference active and reactive power, respectively and v_{gd} represents the instantaneous grid voltage in the dq frame. Under ideal conditions, the grid voltage is pure sinusoidal, thus the magnitude of V_{gd} has a constant value in the dq reference frame because the grid voltage is pure sinusoidal. However, if the grid voltage is distorted, then the magnitude of V_{gd} will not be a constant value. As a result, reference current i_{gd} and i_{gq} cannot be constant [3]. To solve this problem, a low-pass filter (LPF) is used to obtain the average value of V_{gd} i.e., V_{gd0} and the reference currents are modified as follows (2):

$$\begin{aligned} i_{gd} &= \frac{2 P}{3 V_{gd0}} \\ i_{gq} &= \frac{-2 Q}{3 V_{gd0}} \end{aligned} \quad \dots (2)$$

PI-RC Current Controller

An enhanced current controller is proposed by using a PI and RC controllers in the synchronously rotating reference frame. The block diagram of the proposed current controller is shown in Fig. 4. The open loop transfer function of the PI and RC controllers in discrete time domain is given respectively in (3):

$$\begin{aligned} G_{PI}(z) &= K_p + \frac{K_i z}{z-1} \\ G_{RC}(z) &= \frac{K_r z^k z^{-\frac{N}{6}}}{1-Q(z)z^{-\frac{N}{6}}} \end{aligned} \quad \dots (3)$$

where K_p and K_i are the proportional and integral gains of the PI controller, $z^{-\frac{N}{6}}$ is the time delay unit, z^k is the phase lead term, $Q(z)$ is a filter transfer function, and K_r is the RC gain.

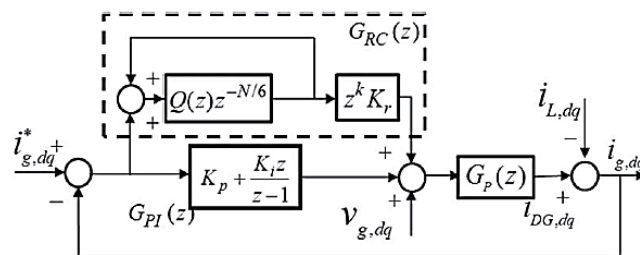

Fig. 4. Block diagram of PI-RC current controller

The RC is used to eliminate the harmonic components in the grid current caused by the nonlinear local loads and/or distorted grid voltage [4]. The function of the PI controller is to improve the

dynamic response of the grid current and also to stabilize the whole control system. The RC has three main components that must be determined: the filter $Q(z)$, the phase lead term z^k , and the RC controller gain K_r [3]. The number of delay samples of the RC given in (3) is $N/6$, where $N = f_{sample}/f_s$ the number of samples is in one fundamental period, which is defined as the ratio of the sampling frequency (f_{sample}) and the fundamental frequency of system (f_s). The main drawback of the traditional RC is that they have got a very slow dynamic response due to the large delay time by N samples. To avoid this problem of delay time of the traditional RC, we consider only the $(6n \pm 1)^{th}$ (where, $n = 1, 2, 3 \dots$) harmonics because they are dominant components in three-phase systems. The time delay of the traditional RC in [2] is thereby reduced by six times compared with the traditional one as $N/6$ [5]. In addition, by utilizing a zero-phase-shift LPF as filter in the proposed RC, the steady state performance of the PCC voltage is improved without any adverse effects on system stability [3].

IV. Simulation Results and Observations

Table 1: System Parameters

PARAMETERS	VALUES
Grid voltage	110 V(rms)
Grid frequency (f_s)	50 Hz
Rated output power	5 KW
DC-link voltage (V_{dc})	350 V
Sampling switching frequency(f_{sample})	9 KHz
Load of 3- ϕ diode rectifier	R=30 Ω C=2200 μ F
3- ϕ linear load	R=30 Ω

The simulation model of the DG system in grid connected mode is built by MATLAB simulation software to verify the effectiveness of the proposed current controller. Table I shows the system parameters. In the simulation, three cases are taken into account:

- 1) Case I: Sinusoidal grid voltage and linear local load.
- 2) Case II: Sinusoidal grid voltage and nonlinear local load.
- 3) Case III: Distorted grid voltage and nonlinear local load.

In Cases I and II, the grid voltage is assumed to be a pure sinusoid. In Case III, the distorted grid voltage is supplied with the 5th harmonic and 7th harmonic components. In all these cases, the reference grid current is set at $i_{gd} = 10A$ and $i_{gq} = 0$ [mains similar]. SVPWM, conventional PI current controller and the proposed PI-RC current controller are analyzed to compare their control performances.

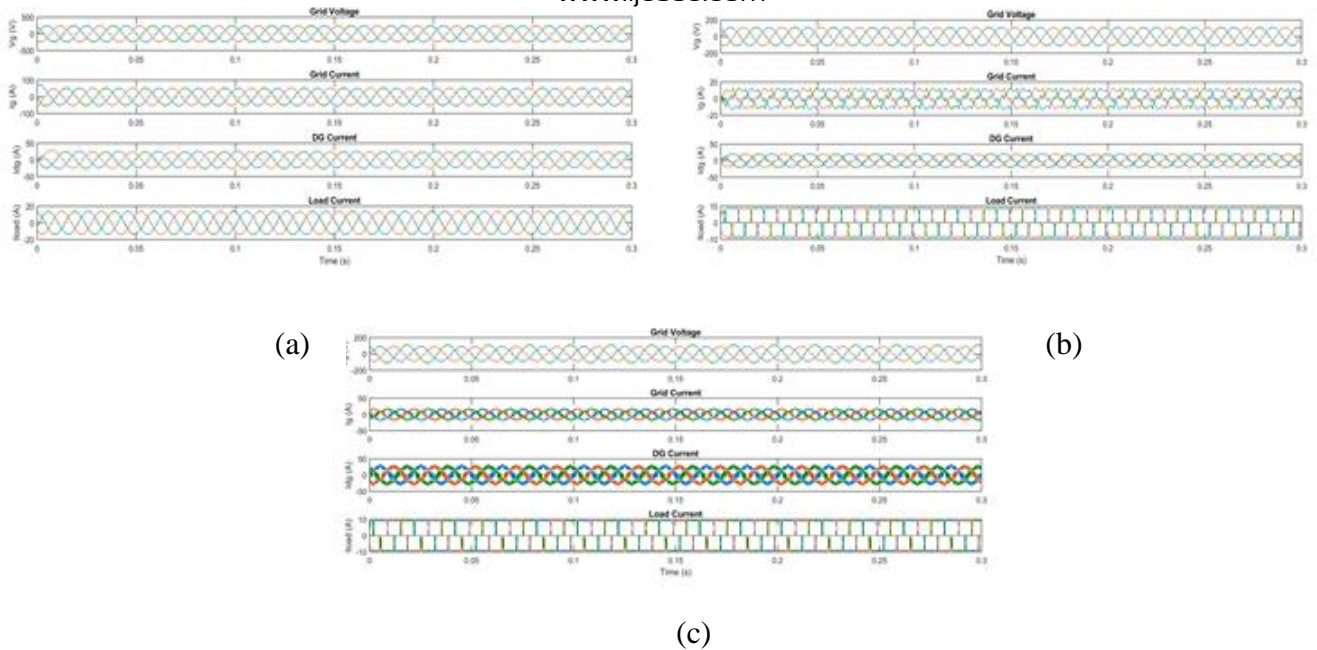

Fig. 8. Simulation results with SVPWM: (a) Case I; (b) Case II; and (c) Case III.

Fig. 8 shows the steady state performance of the DG in grid connected mode by using the conventional SVPWM, in which the waveforms of grid voltage (V_g), grid current (I_g), local load current (I_{load}), and DG current (I_{dg}) are plotted.

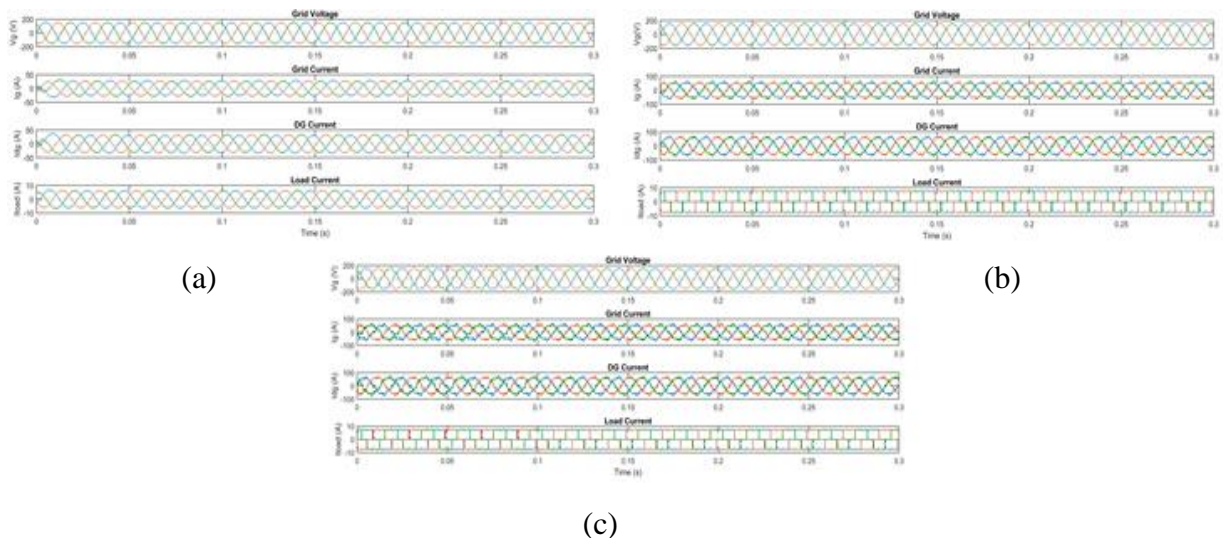

Fig. 9. Simulation results with the PI current controller: (a) Case I; (b) Case II; and (c) Case III.

As shown in Fig. 8, case I with sinusoidal grid voltage and linear local loads provides better performance. Due to the presence of nonlinear DG local load and distribution system, the ideal sinusoidal condition of the grid voltage is very rare. Thus the cases II and III, frequently occur in practice. As a result, the conventional SVPWM is not able to offer a good quality grid current.

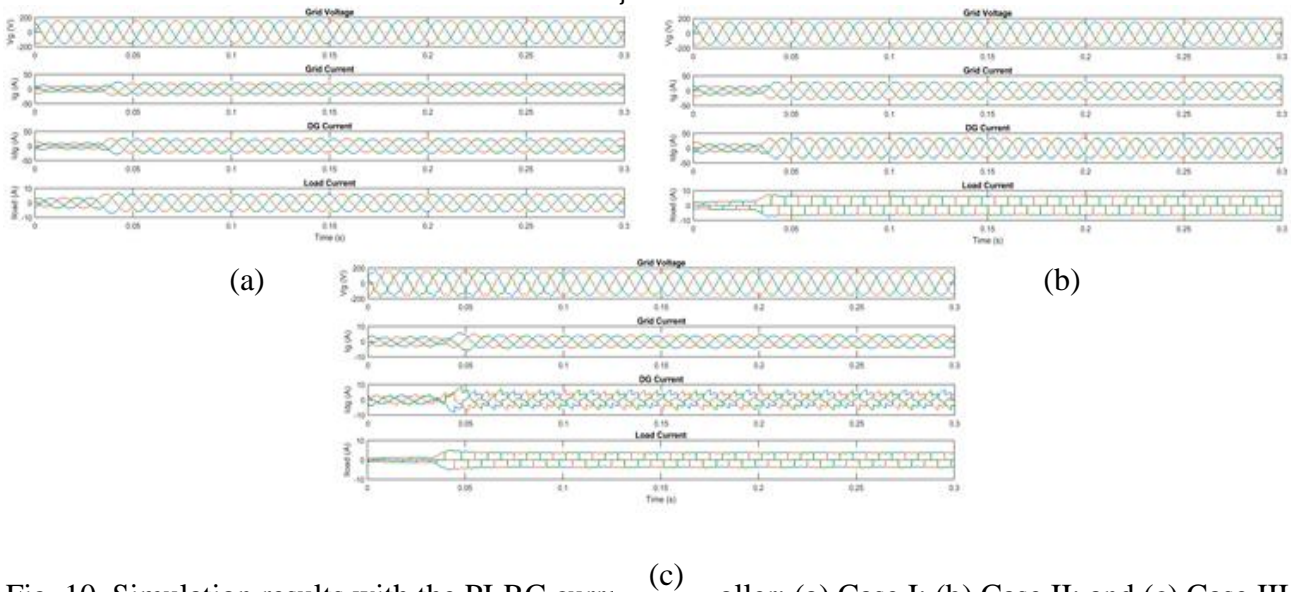

Fig. 10. Simulation results with the PI-RC current controller: (a) Case I; (b) Case II; and (c) Case III.

Fig. 9 shows the steady state performance of the grid connected DG system by using the conventional PI current controller, in which the waveforms of grid voltage (V_g), grid current (I_g), local load current (I_{load}), and DG current (I_{dg}) are plotted. From Fig. 9, it is clear that the conventional PI current controller is able to provide good performance only in Case I, with linear local load and ideal sinusoid grid voltage. In cases II and III, the PI controller offers poor performance. As a result, the conventional PI controller is insufficient to offer a high quality grid current with limited THD value as recommended in IEEE standards. To illustrate the importance of the proposed current controller over the traditional PI controller, the grid connected DG system with the proposed PI-RC current controller is also simulated, and the results are shown in Fig. 10. From the simulation results, it is clear that the proposed control strategy is able to provide a good quality sinusoidal grid current, despite the distorted grid voltage and nonlinear local load conditions. Thus, with the use of the proposed PI-RC current controller, the effect of distorted grid voltage and nonlinear load current, on the grid current quality can be effectively eliminated. The controller integrates the three basic functions required in distributed generation system: power quality, grid synchronization, and successful handling of severe voltage unbalanced conditions. The proposed control method can bring the THD of the grid current to less than 1.5% in all cases, as given in Table II, which complies completely with IEEE 1547 standards. These inferences prove the effectiveness of the proposed current control scheme.

Table 2: Summary of THD Values of Grid Current with SVPWM, PI and Proposed PI-RC current controller

	Conventional closed loop Control (SVPWM)			PI Controller			PI-RC Controller		
	Case I	Case II	Case III	Case I	Case II	Case III	Case I	Case II	Case III
THD of I_g (%)	1.54	20.14	23.53	1.41	12.36	19.83	0.82	1.33	0.79

V. Conclusion

This paper proposes an enhanced current control scheme to eliminate the effects of nonlinear local load and grid voltage distortion in a grid connected DG system, which uses an advanced repetitive controller (RC) combined with PI controller. The analysis and design of the proposed RC were presented in detail. The RC is designed such that the sampling delay is reduced six times compared to the traditional PI-RC, and the dynamic response of the proposed RC is significantly

improved. The proposed controller provides a very fast dynamic response and an excellent steady state performance. The effectiveness of the proposed control strategy is verified through Matlab simulations. The simulation result shows that the grid connected DG system with the proposed current controller transfers a high quality sinusoidal current to the utility grid despite the nonlinear local loads and grid voltage distortions. In the proposed PI-RC controller, RC eliminates harmonic components in grid current caused by nonlinear local load and distorted grid voltage, and PI controller enhances the dynamic response of grid current and also stabilizes the whole control system. The proposed current controller can be easily integrated into the conventional system without installation of extra hardware. The proposed control scheme considerably reduces total harmonic distortion (THD) values. Moreover, the dynamic response of the grid current compensator was greatly enhanced as compared with that of the traditional SVPWM and PI topology.

REFERENCES

- [1]R. C. Dugan and T. E. McDermott, Distributed generation, IEEE Ind. Appl. Mag., vol. 8, no. 2, pp. 19–25, Mar./Apr. 2002.
- [2]Z. Yao and L. Xiao, Control of single-phase grid-connected inverters with nonlinear loads, IEEE Trans. Ind. Electron., vol. 60, no. 4, pp. 1384–1389, Apr. 2013.
- [3]Quoc-Nam Trinh and Hong-Hee Lee, An Enhanced Grid Current Compensator for Grid-Connected Distributed Generation Under Nonlinear Loads and Grid Voltage Distortions, IEEE Trans. Ind. Electron., vol. 61, no. 12, Dec 2014
- [4]Z. Liu, J. Liu, and Y. Zhao, A unified control strategy for three-phase inverter in distributed generation, IEEE Trans. Power Electron., vol. 29, no. 3, pp. 1176–1191, Mar. 2014.
- [5]Quoc-Nam Trinh and Hong-Hee Lee, Advanced Repetitive Controller to Improve the Voltage Characteristics of Distributed Generation with Nonlinear Loads, Journal of Power Electronics, vol. 13, no. 3, May 2013
- [6]F.Blaabjerg, R.Teodorescu, M.Liserre, and A. V. Timbus, Overview of control and grid synchronization for distributed power generation systems, IEEE Trans. Ind. Electron., vol. 53, no. 5, pp. 1398–1409, Oct. 2006.
- [7]S.-H. Ko, S.-W. Lee, S.-R. Lee, C. V. Nayar, and C.-Y. Won, Design considerations for a distributed generation system using a voltage-controlled voltage source inverter, Journal of Power Electronics, Vol. 9, No. 4, pp.643-653, Jul. 2009
- [8]Rong-Jong Wai, Chih-Ying Lin, Yu-Chih Huang, and Yung-Ruei Chang, Design of High-Performance Stand-Alone and Grid-Connected Inverter for Distributed Generation Applications, IEEE Trans. Ind. Electron., vol. 60, no. 4, April 2013.
- [9]J. A. Suul, K. Ljokelsoy, T. Midtsund, and T. Undeland, Synchronous reference frame hysteresis current control for grid converter applications, IEEE Trans. Ind. Appl., vol. 47, no. 5, pp. 2183–2194, Sep./Oct. 2011.
- [10]Q. Zeng and L. Chang, An advanced SVPWM-based predictive current controller for three-phase inverters in distributed generation systems, IEEE Trans. Ind. Electron., vol. 55, no. 3, pp. 1235–1246, Mar. 2008.
- [11]M. Liserre, R. Teodorescu, and F. Blaabjerg, Multiple harmonics control for three-phase grid converter systems with the use of PI-RES current controller in a rotating frame, IEEE Trans. Power Electron., vol. 21, no. 3, pp. 836–841, May 2006.
- [12]R. Teodorescu, F. Blaabjerg, M. Liserre, and P. C. Loh, Proportional resonant controllers and filters for grid-connected voltage-source converters, Proc. Inst. Elect. Eng.—Elect. Power Appl., vol. 153, no. 5, pp. 750–762, Sep. 2006.
- [13]C. A. Busada, S. Gomez Jorge, A. E. Leon, and J. A. Solsona, Current controller based on reduced order generalized integrators for distributed generation systems, IEEE Trans. Ind. Electron., vol. 59, no. 7, pp. 2898–2909, Jul. 2012.

- [14]T.V.Tran, T.-W. Chun,H.-H. Lee, H.-G. Kim, and E.-C. Nho, Control method for reducing the THD of grid current of three-phase grid connected inverters under distorted grid voltages, *J. Power Electron.*, vol. 13, no. 4, pp. 712–718, Jul. 2013.
- [15]Q.-N.Trinh and H.-H. Lee, Improvement of current performance for grid connected converter under distorted grid condition,” in *Proc. IET Conf.RPG*, Sep. 6–8, 2011, pp. 1–6.
- [16]V. Blasko, V. Kaura, Operation of a phase locked loop system under distorted utility conditions, *IEEE Trans. Ind. Electron.*, vol. 33, no. 1, pp. 58–63, Jan./Feb. 1997
- [17]M. Castilla, J. Miret, A. Camacho, J. Matas, and L. G. de Vicuna, Reduction of current harmonic distortion in three-phase grid-connected photovoltaic inverters via resonant current control, *IEEE Trans. Ind. Electron.*, vol. 60, no. 4, pp. 1464–1472, Apr. 2013
- [18]B. Zhang, D. Wang, K. Zhou, and Y. Wang, Linear phase lead compensation repetitive control of a CVCF PWM inverter, *IEEE Trans. Ind. Electron.*, vol. 55, no. 4, pp. 1595–1602, Apr. 2008.
- [19]IEEE Recommended Practices and Requirements for Harmonic Control in Electrical Power Systems, *IEEE Std. 519-1992*, 1992.
- [20]IEC Standard 61000-3-Assessment of emission limits for distorting loads in MV and HV power systems, (1996).